

**Type explanation**

- P** 4-Pipe system  
(2 separate outputs for cool and heat)
- PD** 2-Pipe system  
(1 output for both cool and heat)
- 1S** 1 Fan speed
- 2S** 2 Fan speeds
- 3S** 3 Fan speeds

Back plate view

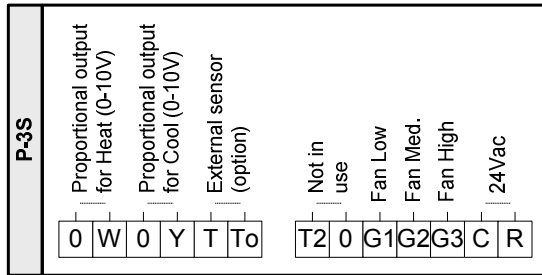

Back plate view

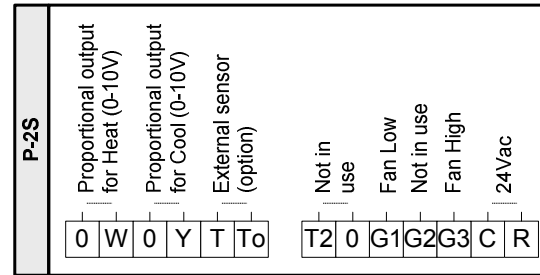

Back plate view

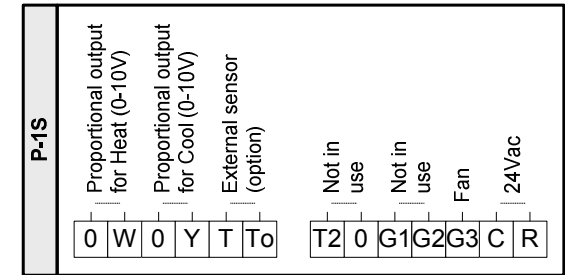

Back plate view

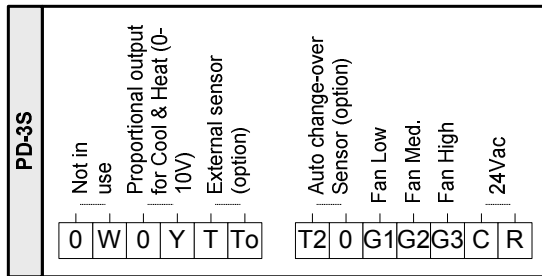

Back plate view

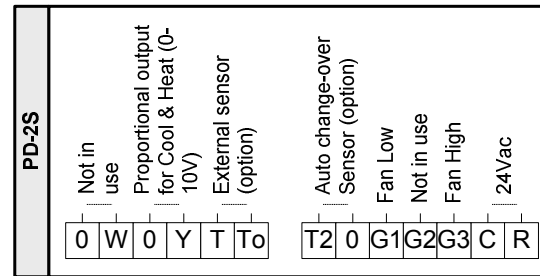

Back plate view

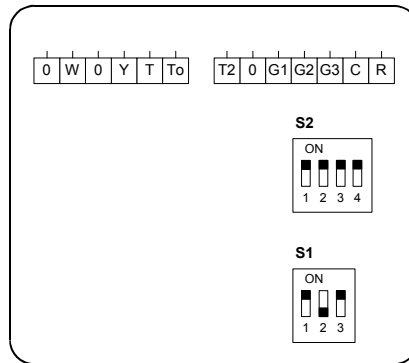
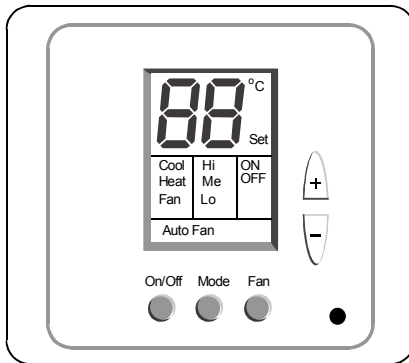
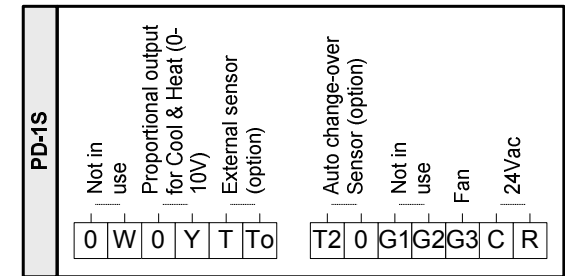

DIP switch S1

Switch no.	Int./Ext. Sensor	
	Internal sensor	External sensor
1	ON*	OFF
2	OFF*	ON
3	ON*	OFF

S1



**Default (internal sensor)**

DIP switch S2

Switch #	Fan speeds			C°/F°		P/PD	
	1 speed	2 speeds	3 speeds	F°	C°	PD (2-Pipe)	P (4-Pipe) Auto change
1	OFF	ON	ON*				
2	OFF	OFF	ON*				
3				OFF	ON*		
4						OFF	ON*

S2



**Default (ETN-24-P-3S-FC-SUPER2)**

**meitav-tec**

Tel: +972-3-9626462  
 Fax: +972-3-9626620  
 e-mail: support@meitavtec.com

Title:  
**ETN24-P/PD-FC-SUPER2**

Date: **13.04.2008**

2  
1

New S/W  
 Original

13.04.08  
 12.12.06

Print name: ETN2P-3S

Software: 08214303

Checksum: E26C

File name: ETN24-P-PD-FC-SUPER2.VSD

Drawn: P.Rechtman

Checked: A.Star

Approved: E.Roy