

ETN-24-P-1S-IR

Owner's Manual – Installation and Operating Instructions



Please read this manual carefully before installation and use.

Index

Options & Accessories	1
Installation Instructions	2
Wiring Connections	3
DIP switch Configuration	4
External Sensor Connection	5
Technician Settings	6
Operating Manual	7

1. Options and Accessories

Remote sensor option:

- TS01: Temperature Sensor with 80cm cable.
- RS01: for remote temperature sensing (1 required); for averaging temperature at 4 locations (4 required) – the thermostat will control on the average temperature of all 4 locations
- RS02: for averaging temperature at 2 locations (2 required) – the thermostat will control on the average temperature of both locations



For details on where to purchase accessories, please contact Meitav-tec or visit our web site at www.meitavtec.com

2. Installation Instructions

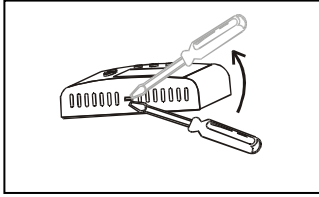

Separate the front panel from back panel by depressing the tongue located in the top of the unit.

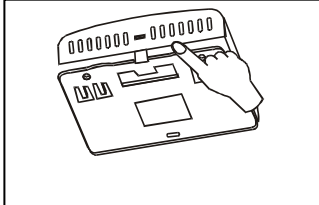

Pull the back panel out.

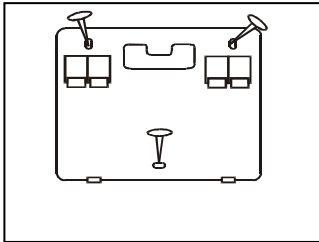

Line the back panel up against the wall or flat surface. Install three screws as required.

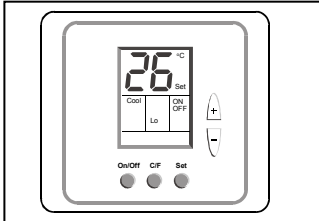

Make electrical connections as shown on enclosed electrical wiring diagram. (Next page) Verify that you have 24 VAC between terminals C and R.

Install the cover to the back panel; first the two tabs on the bottom and then the top tongue. Push until tight against the wall. Wait for 15 seconds for the LCD display to appear (completion of power circuit charging and for self-diagnostics).

3. Wiring Connections

Switch	Function
R	24Vac
C	24Vac
G	Fan

Switch	Function
To	External temperature sensor
T	External temperature sensor
Y	0÷10Vdc output for Cooling
0	Ground for Y
W	0÷10Vdc output for heating
0	Ground for W



Please reference the stickers placed on top of screw terminal connectors on the wall plate when wiring the unit (the designated terminals on the printed circuit board are for internal (factory) use only).



“T”-“T0” Terminals can be used in any system configuration when Meitav-tec external sensor is connected and the DIP switch is correctly configured.

4. DIP Switch Configuration

4.1 The DIP switch is located at the bottom right corner of the board as shown in the drawing. (Inside the thermostat)

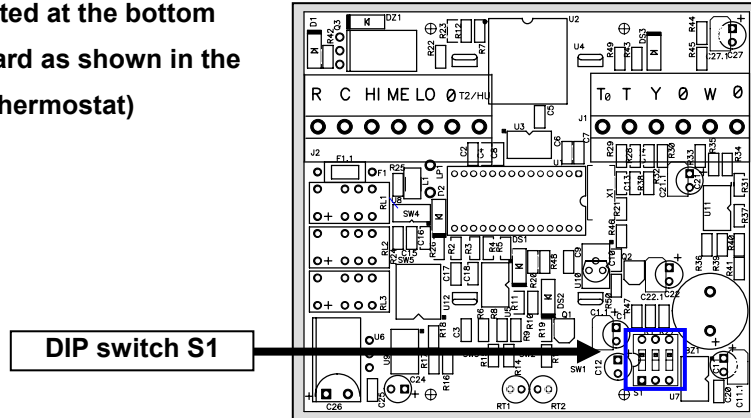

DIP switch S1 (3 switches) configuration

FUNCTION	DIP Switch settings		
	1	2	3
Internal temp. sensor (Default)	ON	OFF	ON
external temp. sensor	OFF	ON	OFF

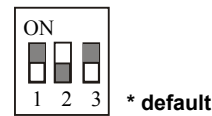

DIP switch S2 (4 switches) is not in use – all switches OFF

5. External sensor connection

 The sensor must be MEITAV-TEC type.

N.T.C. Sensor; Temperature ~ Resistance Characteristics

Temp °C	7.2	10.0	12.8	15.6	18.3	21.1	23.9	26.7	29.4	32.2
Temp °F	45	50	55	60	65	70	75	80	85	90
Res. k	115.8	100.9	88.1	77.1	67.7	59.6	52.5	46.4	41.2	36.6

The default from factory is INTERNAL SENSOR.

- Disconnect power to the thermostat 24 Vac.
- Move DIP switch S1 to external sensor position (1-off, 2-on, 3-off)
- Connect external sensor to terminals T - To.
- Reconnect power to the thermostat.

The length of the cable for the external sensor is 100 feet (30 meters) with standard cable. If longer distance is needed then the cable MUST be shielded.

6. Technician Settings

6.1 Set differential for 0÷10Vdc.

The temperature Differential defines the ratio between the opening level of the damper and the temperature demand. The damper will be fully opened when the demand (demand = ambient temp – set temp) equals the differential.

(Differential range: 2°C÷10°C)

- Press and hold the MODE button – a number will appear on the display.
- Adjust the differential using the “+” or “-” buttons.
(In the picture – the differential was 2°C and changed to 6°C)

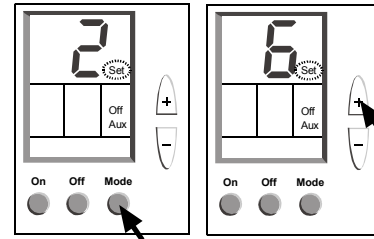

6.2 Proportional output selection 0÷10Vdc or 2÷10Vdc

- Press the MODE button again - “0” and “SET” will appear on display.
- Using the “+” button, change the scale to 2÷10Vdc “2” will appear on display.
- Using the “-” button, change the scale to 0÷10Vdc “0” will appear on display.
- Press the MODE button again to return to normal display mode.
(In the picture – the scale was 2÷10Vdc and changed to 0÷10Vdc)

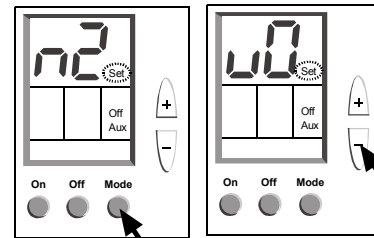

6.3 Set Offset for temperature reading.

The Offset is used for field calibration of the measured temperature if necessary.

(Offset range -6°C÷6°C)

- Press the MODE button again – a number will appear on the display.
- Change the Offset for ambient temperature using the “+” or “-” buttons.
- Press the MODE button again or wait to return to normal display mode.
(In the picture – the offset was 0°C and changed to -2°C)

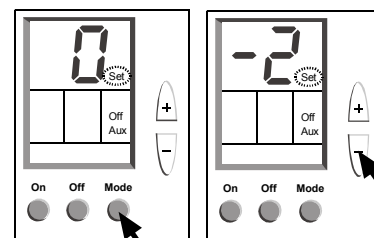

Note: If no key is pressed for 5 seconds, the thermostat will automatically return to normal display mode.

7. Operating manual

7.1 Turn the thermostat on

- Press the ON button to activate the thermostat - The word "ON" will appear on the display.

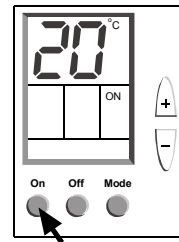

7.2 Turn the thermostat off

- Press the OFF button to deactivate the thermostat - The word "OFF" will appear on the display.

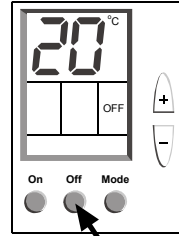

7.3 Temperature set-point adjustment

- Press the "+" or "-" buttons - the set-point temperature will flash and "COOL" and "SET" will appear on display.
- Adjust the cooling set-point temperature using the "+" or "-" buttons.

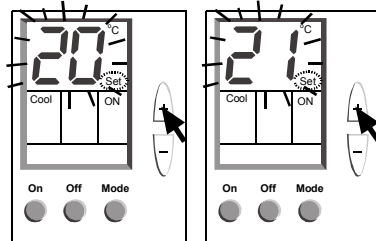

7.4 Select modes

- Press the MODE button to switch between the different mode:
 - Cool
 - Heat
 - Cool/Heat (Auto change-over)
 - Fan only

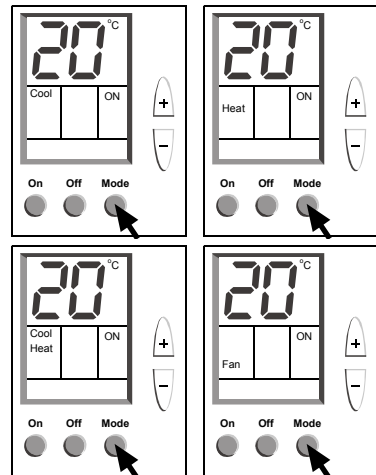

In Cool, Heat and Auto change-over modes, the words "Cool" or "Heat" will flash when there is a demand for cooling or heating.